

LANTURI SI ACCESORII – GRAD 80 DISPOZITIVE DE RIDICARE CU RAMURI DIN LANT

Conform Standardul European

EN 818 – 2 - Lanțuri cu zale scurte pentru ridicat. Reguli de securitate.

Partea 2: Lanț de toleranță mijlocie pentru lanțuri de legare. Clasa 8

1. Sarcina Utila de Lucru/ Working Load Limits (W.L.L.)

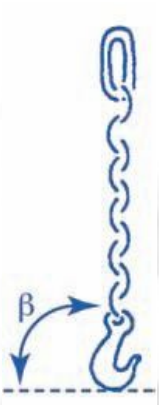
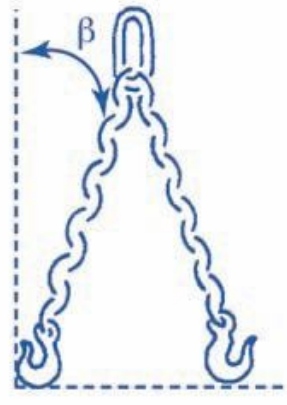
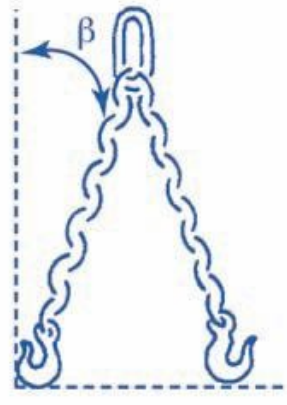
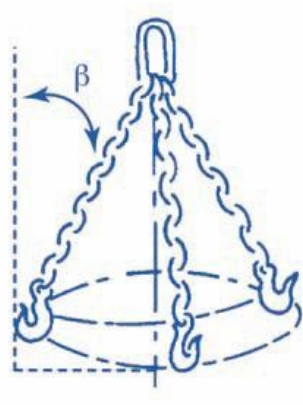
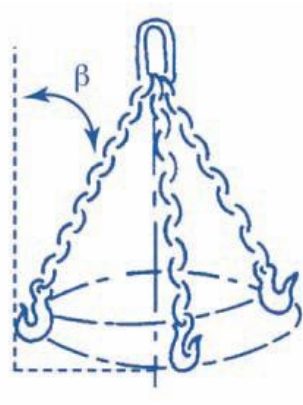
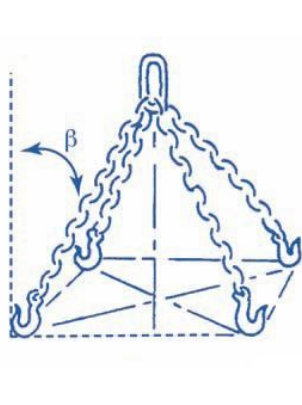
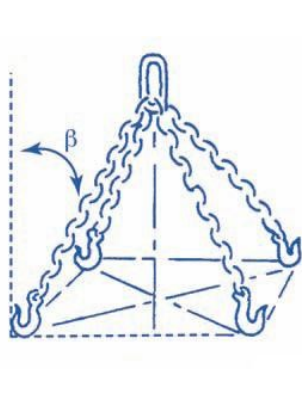
|  Ø LANT | 1 BRAT | 2 BRATE | | 3 BRATE | | 4 BRATE | |
|---|--|--|--|---|---|--|--|
| |  |  |  |  |  |  |  |
| UNGHIU DE UNCLINARE | - | 0- 45° | 45° - 60° | 0° - 45° | 45° - 60° | 0° - 45° | 45° - 60° |
| Factor de incarcare | 1 | 1,4 | 1 | 2,1 | 1,5 | 2,1 | 1,5 |
| d | Capacitatea de ridicare (kg.) | | | | | | |
| 7 | 1.500 | 2.120 | 1.500 | 3.150 | 2.250 | 3.150 | 2.250 |
| 8 | 2.000 | 2.800 | 2.000 | 4.250 | 3.000 | 4.250 | 3.000 |
| 10 | 3.150 | 4.200 | 3.150 | 6.700 | 4.750 | 6.700 | 4.750 |
| 13 | 5.300 | 7.500 | 5.300 | 11.200 | 8.000 | 11.200 | 8.000 |
| 16 | 8.000 | 11.200 | 8.000 | 17.000 | 11.800 | 17.000 | 11.800 |
| Factorii si capacitatea de ridicare in conformitate cu EN 818 - 4 | | | | | | | |

CAPACITATEA DE RIDICARE IN FUNCTIE DE GAMA DE TEMPERATURA

| de la -40°C pana la +200°C | de la +200°C pana la +300°C | de la +300°C pana la +400°C |
|----------------------------|-----------------------------|-----------------------------|
| 100% | 90% | 75% |

LANT DE RIDICARE GRAD 80 – EN 818-2

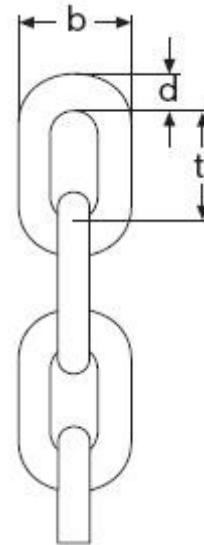

| DIAMETRU NOMINAL | CAPACITATEA DE RIDICARE | GREUTATE PROPRIE | DIMENSIUNI IN mm | | |
|---------------------|----------------------------|---------------------|------------------|----|----|
| | | | d | t | b |
| mm | kg | Kg/ m | | | |
| 7 - 8 | 1.500 | 1,10 | 7 | 21 | 24 |
| 8 - 8 | 2.000 | 1,40 | 8 | 24 | 28 |
| 10 - 8 | 3.150 | 2,20 | 10 | 30 | 35 |
| 13 - 8 | 5.300 | 3,80 | 13 | 39 | 46 |
| 16 - 8 | 8.000 | 5,70 | 16 | 48 | 57 |

INEL PRINCIPAL PENTRU DISPOZITIV CU 1 BRAT DE LANT Tip A1

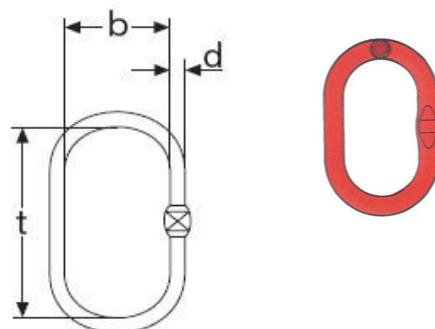

| DIAMETRU NOMINAL | CAPACITATEA DE RIDICARE | GREUTATE PROPRIE | DIMENSIUNI IN mm | | |
|------------------|-------------------------|------------------|------------------|-----|-----|
| | | | d | t | b |
| mm | kg | Kg/ buc | | | |
| 6/7 - 8 | 1.120 | 0,34 | 13 | 110 | 60 |
| 8 - 8 | 2.000 | 0,55 | 16 | 110 | 60 |
| 10 - 8 | 3.150 | 0,82 | 18 | 135 | 75 |
| 13 - 8 | 5.300 | 1,50 | 22 | 160 | 90 |
| 16 - 8 | 8.000 | 2,40 | 26 | 180 | 100 |

INEL PRINCIPAL PENTRU DISPOZITIV CU 2 BRATE DE LANT Tip A2

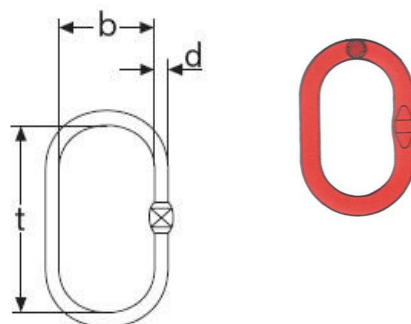

| DIAMETRU NOMINAL | CAPACITATEA DE RIDICARE | GREUTATE PROPRIE | DIMENSIUNI IN mm | | |
|------------------|-------------------------|------------------|------------------|-----|-----|
| | | | d | t | b |
| mm | kg | Kg/ buc | | | |
| 7 - 8 | 2.120 | 0,55 | 16 | 110 | 60 |
| 8 - 8 | 2.800 | 0,82 | 18 | 135 | 75 |
| 10 - 8 | 4.250 | 1,50 | 22 | 160 | 90 |
| 13 - 8 | 7.500 | 2,40 | 26 | 180 | 100 |
| 16 - 8 | 11.200 | 4,00 | 32 | 200 | 120 |

INEL PRINCIPAL PENTRU DISPOZITIV CU 3 - 4 BRATE DE LANT Tip KG

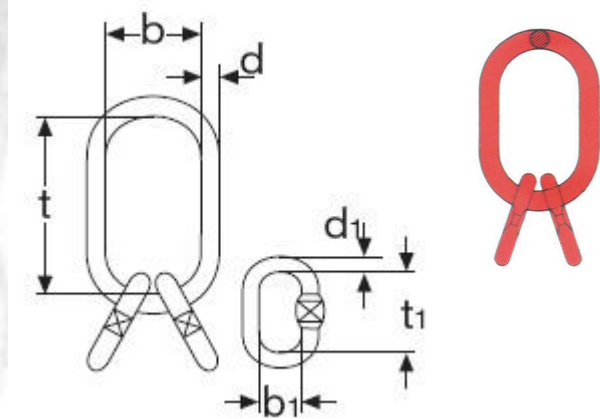

| DIAMETRU NOMINAL | CAPACITATEA DE RIDICARE | GREUTATE PROPRIE | DIMENSIUNI IN mm | | | | | |
|------------------|-------------------------|------------------|------------------|-----|-----|----|-----|----|
| mm | kg | Kg/ buc | d | t | b | d1 | t1 | b1 |
| 6/7 - 8 | 3.150 | 1,16 | 18 | 135 | 75 | 13 | 54 | 25 |
| 8 - 8 | 4.250 | 2,22 | 22 | 160 | 90 | 16 | 70 | 34 |
| 10 - 8 | 6.700 | 3,36 | 26 | 180 | 100 | 18 | 85 | 40 |
| 13 - 8 | 11.200 | 6,02 | 32 | 200 | 110 | 22 | 115 | 50 |
| 16 - 8 | 17.000 | 9,95 | 36 | 260 | 140 | 26 | 140 | 65 |

CARLIG CU SIGURANTA SI OCHI (OCHETE – PENTRU CABLU) LHS

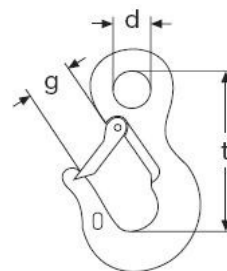

| DIAMETRU NOMINAL | CAPACITATEA DE RIDICARE | GREUTATE PROPRIE | DIMENSIUNI IN mm | | |
|------------------|-------------------------|------------------|------------------|-----|------|
| mm | kg | Kg/ buc | d | t | g |
| 6/7 - 8 | 1.500 | 0,40 | 25 | 103 | 31,5 |
| 8 - 8 | 2.000 | 0,80 | 28 | 116 | 35,5 |
| 10 - 8 | 3.150 | 1,20 | 35,5 | 145 | 45 |
| 13 - 8 | 5.300 | 2,50 | 45 | 180 | 56 |
| 16 - 8 | 8.000 | 3,50 | 37 | 164 | 58 |

CARLIG CU SIGURANTA (PENTRU LANT) Tip LHGS

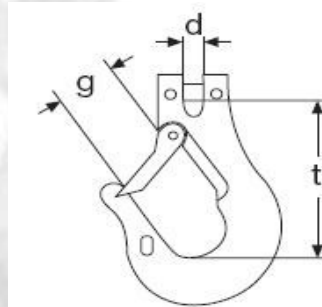

| DIAMETRU NOMINAL | CAPACITATEA DE RIDICARE | GREUTATE PROPRIE | DIMENSIUNI IN mm | | |
|------------------|-------------------------|------------------|------------------|-----|----|
| | | | d | t | g |
| mm | kg | Kg/ buc | | | |
| 6/7 - 8 | 1.500 | 0,25 | 8 | 86 | 32 |
| 8 - 8 | 2.000 | 0,60 | 9 | 99 | 34 |
| 10 - 8 | 3.150 | 1,00 | 13 | 121 | 44 |
| 13 - 8 | 5.300 | 2,00 | 16 | 153 | 55 |
| 16 - 8 | 8.000 | 3,45 | 20 | 130 | 57 |

CARLIG CU CU AUTOBLOCARE SI OCHI KUN Tip LS

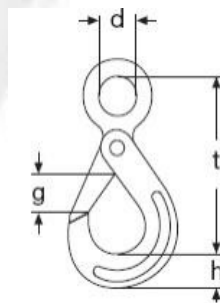

| DIAMETRU NOMINAL | CAPACITATEA DE RIDICARE | GREUTATE PROPRIE | DIMENSIUNI IN mm | | |
|------------------|-------------------------|------------------|------------------|-----|----|
| | | | d | t | g |
| mm | kg | Kg/ buc | | | |
| 7/8 - 8 | 2.000 | 1,00 | 25 | 134 | 38 |
| 10 - 8 | 3.150 | 2,00 | 31 | 168 | 52 |
| 13 - 8 | 5.300 | 3,50 | 39 | 209 | 62 |
| 16 - 8 | 8.000 | 6,70 | 50 | 275 | 75 |

CARLIG CU AUTOBLOCARE (PENTRU LANT) Tip LSG

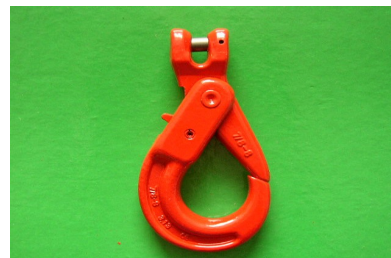
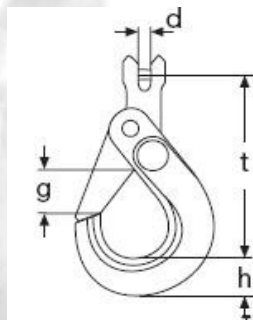

| DIAMETRU NOMINAL | CAPACITATEA DE RIDICARE | GREUTATE PROPRIE | DIMENSIUNI IN mm | | |
|------------------|-------------------------|------------------|------------------|-----|----|
| | | | d | t | g |
| mm | kg | Kg/ buc | | | |
| 7/8 - 8 | 2.000 | 1,00 | 10 | 133 | 38 |
| 10 - 8 | 3.150 | 2,00 | 12 | 164 | 52 |
| 13 - 8 | 5.300 | 3,60 | 16 | 206 | 62 |
| 16 - 8 | 8.000 | 6,50 | 19 | 236 | 75 |

CARLIG DE TURNATORIE Tip LG

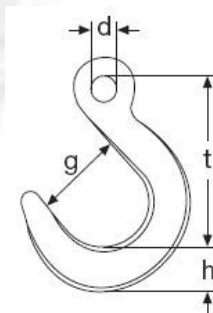

| DIAMETRU NOMINAL | CAPACITATEA DE RIDICARE | GREUTATE PROPRIE | DIMENSIUNI IN mm | | |
|------------------|-------------------------|------------------|------------------|-----|-----|
| | | | d | t | g |
| mm | kg | Kg/ buc | | | |
| 8 - 8 | 2.000 | 1,10 | 18 | 123 | 64 |
| 10 - 8 | 3.150 | 2,10 | 22 | 148 | 78 |
| 13 - 8 | 5.300 | 3,50 | 27 | 175 | 89 |
| 16 - 8 | 8.000 | 5,30 | 35 | 207 | 102 |

CARLIG ROTATIV CU LAGAR DE ALUNECARE Tip LHW

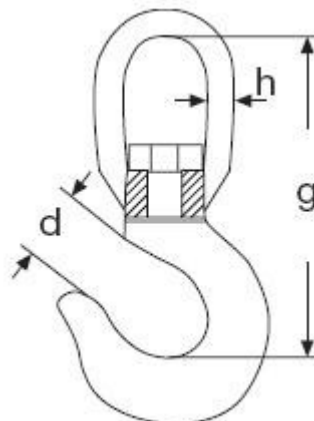

| CAPACITATEA DE RIDICARE | GREUTATE PROPRIE | DIMENSIUNI IN mm | | |
|-------------------------|------------------|------------------|---------|----|
| | | kg | Kg/ buc | h |
| 1.600 | 0,85 | 13,5 | 145 | 21 |
| 3.200 | 1,51 | 17 | 175 | 27 |
| 5.400 | 3,70 | 21 | 214 | 32 |
| 8.000 | 6,60 | 26 | 264 | 40 |
| 11.500 | 10,25 | 29 | 308 | 50 |
| 16.000 | 15,80 | 34,5 | 344 | 58 |
| 22.000 | 26,00 | 40 | 427 | 78 |
| 30.000 | 60,00 | 48 | 505 | 82 |

CARLIG Tip CHH

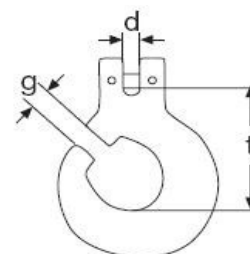

| DIAMETRU NOMINAL | CAPACITATEA DE RIDICARE | GREUTATE PROPRIE | DIMENSIUNI IN mm | | |
|------------------|-------------------------|------------------|------------------|----|---------|
| | | | mm | kg | Kg/ buc |
| 7/8 - 8 | 2.000 | 0,48 | 25 | 58 | 9,8 |
| 10 - 8 | 3.150 | 0,89 | 33 | 84 | 12,9 |
| 13 - 8 | 5.300 | 1,50 | 40 | 94 | 16 |

CARLIG MODEL C Tip GH

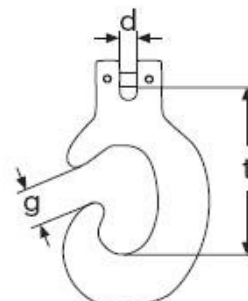

| DIAMETRU NOMINAL | CAPACITATEA DE RIDICARE | GREUTATE PROPRIE | DIMENSIUNI IN mm | | |
|------------------|-------------------------|------------------|------------------|-----|----|
| | | | d | t | g |
| 7/8 - 8 | 2.000 | 0,56 | 27 | 90 | 20 |
| 10 - 8 | 3.150 | 1,40 | 39 | 129 | 28 |
| 13 - 8 | 5.300 | 3,00 | 51 | 166 | 39 |

CUPLA DE LEGATURA Tip VH

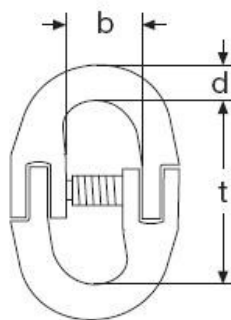

| DIAMETRU NOMINAL | CAPACITATEA DE RIDICARE | GREUTATE PROPRIE | DIMENSIUNI IN mm | | |
|------------------|-------------------------|------------------|------------------|-----|------|
| | | | d | t | b |
| 7/8 - 8 | 2.000 | 0,18 | 10 | 55 | 20,5 |
| 10 - 8 | 3.150 | 0,30 | 12,5 | 68 | 27,5 |
| 13 - 8 | 5.300 | 0,60 | 17 | 85 | 31 |
| 16 - 8 | 8.000 | 1,30 | 21,5 | 105 | 36 |

CUPLA DE LANT Tip OS

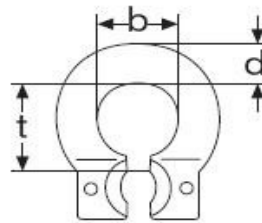

| DIAMETRU NOMINAL | CAPACITATEA DE RIDICARE | GREUTATE PROPRIE | DIMENSIUNI IN mm | | |
|------------------|-------------------------|------------------|------------------|----|----|
| | | | d | t | b |
| 7/8 - 8 | 2.000 | 0,18 | 18 | 32 | 24 |
| 10 - 8 | 3.150 | 0,35 | 19 | 44 | 32 |
| 13 - 8 | 5.300 | 0,72 | 25 | 55 | 40 |
| 16 - 8 | 8.000 | 1,20 | 30 | 65 | 50 |

CARLIG DE SCURTARE CU OCHI Tip LP

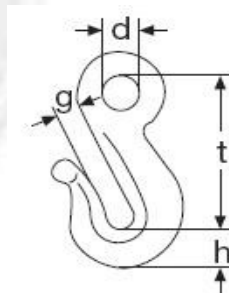

| DIAMETRU NOMINAL | CAPACITATEA DE RIDICARE | GREUTATE PROPRIE | DIMENSIUNI IN mm | | |
|------------------|-------------------------|------------------|------------------|-----|----|
| | | | d | t | g |
| 6/8 - 8 | 2.000 | 0,15 | 15 | 61 | 9 |
| 10 - 8 | 3.150 | 0,50 | 19 | 80 | 12 |
| 13 - 8 | 5.300 | 0,90 | 25 | 101 | 15 |
| 16 - 8 | 8.000 | 1,70 | 31 | 122 | 19 |

CARLIG DE SCURTARE PENTRU LANT Tip LPG

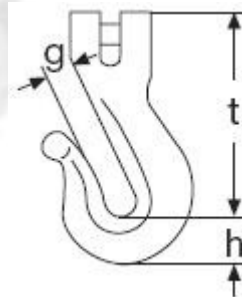

| DIAMETRU NOMINAL | CAPACITATEA DE RIDICARE | GREUTATE PROPRIE | DIMENSIUNI IN mm | |
|------------------|-------------------------|------------------|------------------|----|
| | | | t | g |
| mm | kg | Kg/ buc | | |
| 7/8 - 8 | 2.000 | 0,27 | 50 | 10 |
| 10 - 8 | 3.150 | 0,75 | 72 | 13 |
| 13 - 8 | 5.300 | 1,35 | 88 | 17 |
| 16 - 8 | 8.000 | 2.30 | 102 | 20 |

CLESTE DE SCURTARE CU OCHI Tip LK

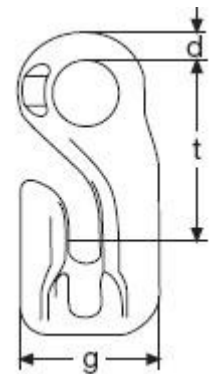

| DIAMETRU NOMINAL | CAPACITATEA DE RIDICARE | GREUTATE PROPRIE | DIMENSIUNI IN mm | | |
|------------------|-------------------------|------------------|------------------|-----|----|
| | | | d | t | g |
| mm | kg | Kg/ buc | | | |
| 7/8 - 8 | 3.150 | 0,50 | 25 | 60 | 48 |
| 10 - 8 | 3.150 | 0,80 | 32 | 75 | 60 |
| 13 - 8 | 5.300 | 0,80 | 40 | 95 | 78 |
| 16 - 8 | 8.000 | 3,30 | 50 | 120 | 96 |

CLESTE DE SCURTARE PENTRU LANT KUN 3.09, Tip LKG

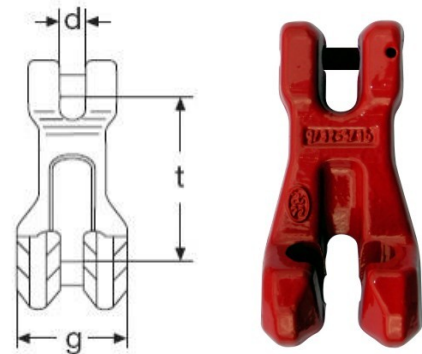

| DIAMETRU NOMINAL | CAPACITATEA DE RIDICARE | GREUTATE PROPRIE | DIMENSIUNI IN mm | |
|------------------|-------------------------|------------------|------------------|----|
| | | | t | g |
| mm | kg | Kg/ buc | | |
| 7/8 - 8 | 2.000 | 0,27 | 50 | 10 |
| 10 - 8 | 3.150 | 0,75 | 72 | 13 |
| 13 - 8 | 5.300 | 1,35 | 88 | 17 |
| 16 - 8 | 8.000 | 2.30 | 102 | 20 |



Alege calitatea pentru siguranța ta!



S.C. TOTAL RACE IMPEX S.R.L. Tel. 0728-305-610 / 0728-305-611 / 0728-305-612
Str.Uverturii 69A, Et.1, Sector 6, Fax 0314-201-352 / 0214-301-206
RO-060933 BUCURESTI info@totalrace.ro / vanzari@totalrace.ro
ROMANIA www.totalrace.ro / www.lanturideridicat.ro



Contact: Bucuresti Sector 6 Bulevardul Uverturii 69 A

Tel. / Fax : 0314201352

Mobil: 0728305610 / 0728305611 / 0728305612

e-mail: info@totalrace.ro / vanzari@totalrace.ro

www.totalrace.ro

www.lanturichingi.ro

www.echipamentemacara.ro



DISPOZITIVE CU MAI MULTE RAMURI DE LANT

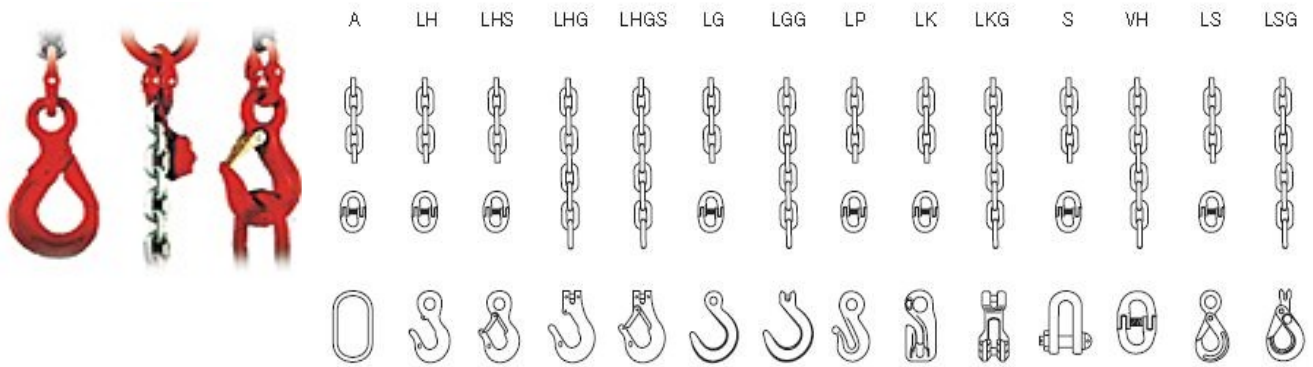

DIVERSE MODELE



Toate modele de accesorii si dispozitive de lant sunt productie Germania, se livreaza insotite de Certificat de Testare emis de producator, Declaratie de Conformitate emisa de importatorul autorizat Total Race, Instructiuni de Utilizare, Tabel de sarcini.

Preturile sunt in Euro si nu include TVA.

Plata se va face in RON la cursul BNR din ziua emiterii facturii.

Termen de livrare: max. 24 ore de la comanda ferma, pentru produsele aflate in stoc.